

# Scandic® rainwater system Technical catalog

Informational data for packaging and transportation



# Content

- 4 JB - Gutter L-3000
- 5 JB -Gutter L-4000
- 6 BJ - Gutter joint
- 7 CU - Universal stop end
- 8 CJ - Gutter bracket
- 9 CJL - Long gutter bracket
- 10 CPU - Universal bracket
- 11 PPC/ PPCR - Bracket support/ twisted
- 12 KEB - External 90° corner with brackets
- 13 KIB - Internal 90° corner with brackets
- 14 KE - External 90° corner
- 15 KI - Internal 90° corner
- 16 PP - Straight overflow element 180°
- 17 PP - Corner overflow element 90°
- 18 PCD - Rectangular hopper
- 19 PC - Round hopper
- 20 RA - Gutter outlet
- 21 CB - Downpipe bend 60°
- 22 BU - Downpipe L-3000
- 23 PB - Intermediate downpipe L-1000
- 24 BB - Downpipe holder
- 25 MB - Downpipe connector
- 26 RB - Downpipe branch
- 27 EC - Rainwater diverter
- 28 CE - Shoe 60°
- 29 RC - Drain connector
- 30 DEP - Decanter, CEL - Elastic bend
- 31 EJ - Gutter joint element, SJ - Gutter stabilizer

Check our **Installation video instructions!**  
RoofArt's youtube channel: [youtube.com/RoofArtEU/videos](https://www.youtube.com/Channel/UCRoofArtEU/videos)  
Video name: Scandic® Rainwater System – Mounting guidelines



ZINC  
★★

COLOR  
★★★

COPPER  
★★★★

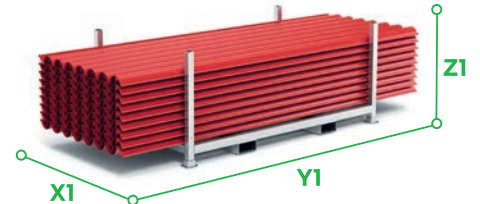

**Element size (mm)**

	125/87	150/100
<b>A</b>	125	150
<b>B</b>	18	20
<b>C</b>	3000	3000
<b>D</b>	62	86
<b>E</b>	68	97

**Pallet size (mm)**

	125/87	150/100
<b>X1</b>	1200	1200
<b>Y1</b>	3000	3000
<b>Z1</b>	810	810

**JB 125**

**JB 150**

EAN-13 barcode	Colors	RAL	EAN-13 barcode
4.841.159.000.635	Wine red	3005	4.841.159.001.939
4.841.159.000.376	Oxide red	3009	4.841.159.001.670
4.841.159.000.116	Red	3011	4.841.159.001.410
4.841.159.010.450	Chrome green	6020	4.841.159.010.757
4.841.159.007.191	Iron grey	7011	4.841.159.007.481
4.841.159.016.964	Anthracite grey	7016	4.841.159.017.244
4.841.159.007.771	Copper brown	8004	4.841.159.008.068
4.841.159.000.895	Chocolate brown	8017	4.841.159.002.196
4.841.159.005.821	Grey brown	8019	4.841.159.006.118
4.841.159.006.408	Black	9005	4.841.159.006.699
4.841.159.001.151	Pure white	9010	4.841.159.002.455
4.841.159.005.265	Copper		4.841.159.005.548
4.841.159.004.015	Zinc		4.841.159.004.275

**JB 125    JB 150**

<b>Pieces in pack</b>		
	5	5
<b>Packs on pallet</b>		
	65	55
<b>Pack</b>		
	16.5	22
<b>Pallet</b>		
	1156	1294

NOTE: The real Colors might be different from printed Colors on the leaflets. Please, see the samples before choosing the desired color.

EN 612:2006

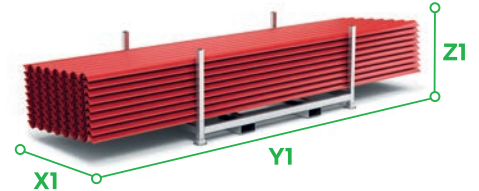
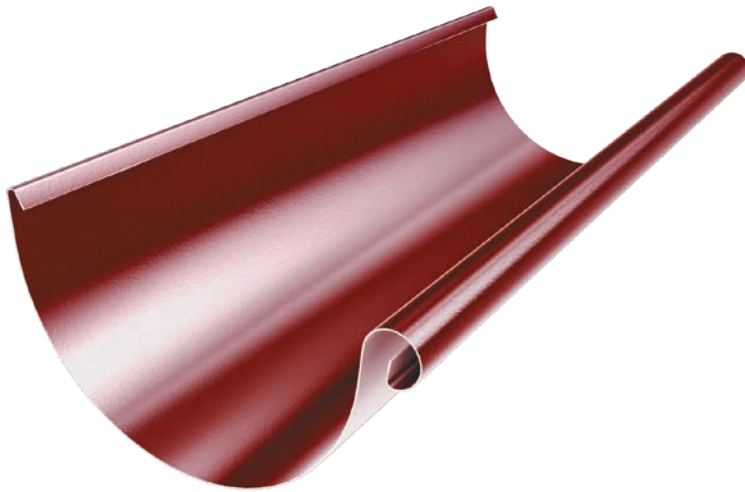

**Element size (mm)**













	125/87	150/100
<b>A</b>	125	150
<b>B</b>	18	20
<b>C</b>	4000	4000
<b>D</b>	62	86
<b>E</b>	68	97

**Pallet size (mm)**





	125/87	150/100
<b>X1</b>	1200	1200
<b>Y1</b>	4000	4000
<b>Z1</b>	810	810

**JB 125**

**JB 150**

EAN-13 barcode	Colors	RAL	EAN-13 barcode
4.841.159.000.642	Wine red	 3005	4.841.159.001.946
4.841.159.000.383	Oxide red	 3009	4.841.159.001.687
4.841.159.000.123	Red	 3011	4.841.159.001.427
4.841.159.010.467	Chrome green	 6020	4.841.159.010.764
4.841.159.007.207	Iron grey	 7011	4.841.159.007.498
4.841.159.016.995	Anthracite grey	 7016	4.841.159.017.251
4.841.159.007.788	Copper brown	 8004	4.841.159.008.075
4.841.159.000.901	Chocolate brown	 8017	4.841.159.002.202
4.841.159.005.838	Grey brown	 8019	4.841.159.006.125
4.841.159.006.415	Black	 9005	4.841.159.006.705
4.841.159.001.168	Pure white	 9010	4.841.159.002.462
4.841.159.005.272	Copper		4.841.159.005.555
4.841.159.004.022	Zinc		4.841.159.004.282

**JB 125    JB 150**

<b>Pieces in pack</b>		
	5	5
<b>Packs on pallet</b>		
	52	44
<b>Pack</b>		
 kg	22.0	29.3
<b>Pallet</b>		
 kg	1228	1373

NOTE: The real Colors might be different from printed Colors on the leaflets. Please, see the samples before choosing the desired color.

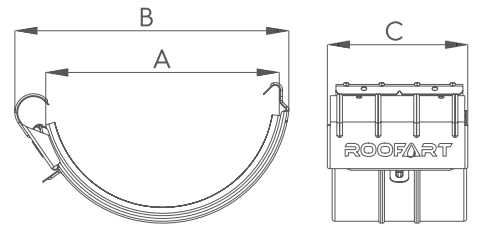

Element size (mm)

	125/87	150/100
<b>A</b>	125	150
<b>B</b>	145	176
<b>C</b>	72	72

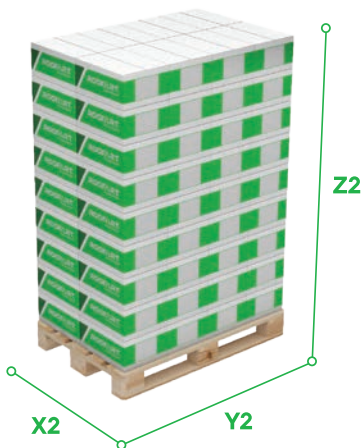

Pallet size (mm)

	125/87	150/100
<b>X2</b>	800	800
<b>Y2</b>	1200	1200
<b>Z2</b>	1680	1680

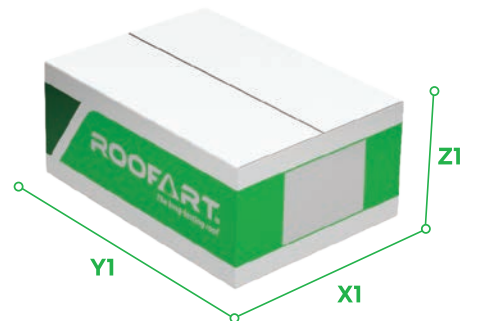

Box size (mm)

	125/87	150/100
<b>X1</b>	290	290
<b>Y1</b>	390	390
<b>Z1</b>	170	170

**BJ 125**

**BJ 150**

EAN-13 barcode	Colors	RAL	EAN-13 barcode
4.841.159.000.659	Wine red	3005	4.841.159.001.953
4.841.159.000.390	Oxide red	3009	4.841.159.001.694
4.841.159.000.130	Red	3011	4.841.159.001.434
4.841.159.010.474	Chrome green	6020	4.841.159.010.771
4.841.159.007.214	Iron grey	7011	4.841.159.007.504
4.841.159.016.988	Anthracite grey	7016	4.841.159.017.268
4.841.159.007.795	Copper brown	8004	4.841.159.008.082
4.841.159.000.918	Chocolate brown	8017	4.841.159.002.219
4.841.159.005.845	Grey brown	8019	4.841.159.006.132
4.841.159.006.422	Black	9005	4.841.159.006.712
4.841.159.001.175	Pure white	9010	4.841.159.002.479
4.841.159.005.289	Copper		4.841.159.005.562
4.841.159.004.039	Zinc		4.841.159.004.299

**BJ 125 BJ 150**

	BJ 125	BJ 150
<b>Pieces in box</b>		
	40	40
<b>Boxes on pallet</b>		
	72	72
<b>Box</b>		
	5.8	7.3
<b>Pallet</b>		
	438	546

NOTE: The real Colors might be different from printed Colors on the leaflets. Please, see the samples before choosing the desired color.

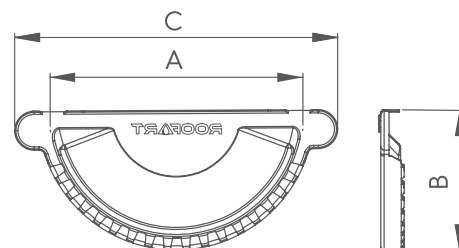

Element size (mm)

	125/87	150/100
<b>A</b>	125	150
<b>B</b>	69	95
<b>C</b>	159	192

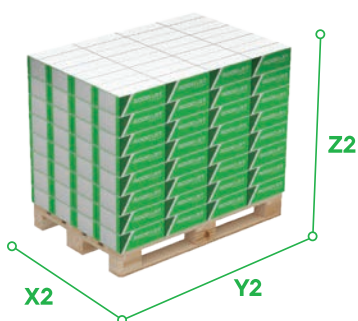

Pallet size (mm)

	125/87	150/100
<b>X2</b>	800	800
<b>Y2</b>	1200	1200
<b>Z2</b>	1030	1030















Box size (mm)





	125/87	150/100
<b>X1</b>	200	200
<b>Y1</b>	300	300
<b>Z1</b>	110	110

**CU 125**

**CU 150**

EAN-13 barcode	Colors	RAL	EAN-13 barcode
4.841.159.000.666	Wine red	 3005	4.841.159.001.960
4.841.159.000.406	Oxide red	 3009	4.841.159.001.700
4.841.159.000.147	Red	 3011	4.841.159.001.441
4.841.159.010.481	Chrome green	 6020	4.841.159.010.788
4.841.159.007.221	Iron grey	 7011	4.841.159.007.511
4.841.159.017.008	Anthracite grey	 7016	4.841.159.017.275
4.841.159.007.801	Copper brown	 8004	4.841.159.008.099
4.841.159.000.925	Chocolate brown	 8017	4.841.159.002.226
4.841.159.005.852	Grey brown	 8019	4.841.159.006.149
4.841.159.006.439	Black	 9005	4.841.159.006.729
4.841.159.001.182	Pure white	 9010	4.841.159.002.486
4.841.159.005.296	Copper		4.841.159.005.579
4.841.159.004.046	Zinc		4.841.159.004.305

**CU 125 CU 150**

<b>Pieces in box</b>		
	34	27
<b>Boxes on pallet</b>		
	128	128
<b>Box</b>		
	2.1	2.6
<b>Pallet</b>		
	290	353

NOTE: The real Colors might be different from printed Colors on the leaflets. Please, see the samples before choosing the desired color.

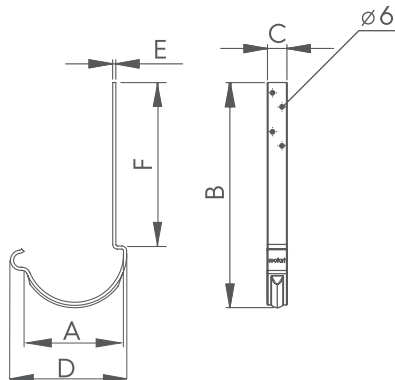

Element size (mm)

	125/87	150/100
<b>A</b>	125	150
<b>B</b>	256	290
<b>C</b>	25	30
<b>D</b>	150	177
<b>E</b>	4	4
<b>F</b>	185	185

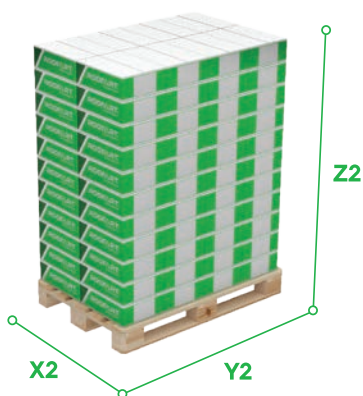
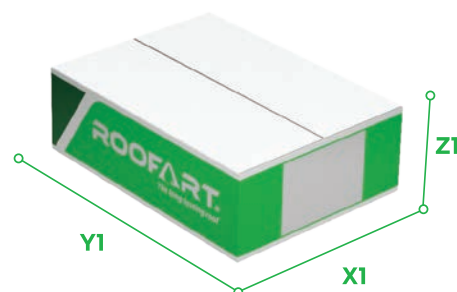

Pallet size (mm)













	125/87	150/100
<b>X2</b>	800	800
<b>Y2</b>	1200	1200
<b>Z2</b>	1580	1580

Box size (mm)

	125/87	150/100
<b>X1</b>	290	290
<b>Y1</b>	390	390
<b>Z1</b>	130	130





**CJ 125**

**CJ 150**

EAN-13 barcode	Colors	RAL	EAN-13 barcode
4.841.159.000.673	Wine red	 3005	4.841.159.001.977
4.841.159.000.413	Oxide red	 3009	4.841.159.001.717
4.841.159.000.154	Red	 3011	4.841.159.001.458
4.841.159.010.498	Chrome green	 6020	4.841.159.010.795
4.841.159.007.238	Iron grey	 7011	4.841.159.007.528
4.841.159.017.015	Anthracite grey	 7016	4.841.159.017.282
4.841.159.007.818	Copper brown	 8004	4.841.159.008.105
4.841.159.000.932	Chocolate brown	 8017	4.841.159.002.233
4.841.159.005.869	Grey brown	 8019	4.841.159.006.156
4.841.159.006.446	Black	 9005	4.841.159.006.736
4.841.159.001.199	Pure white	 9010	4.841.159.002.493
4.841.159.005.302	Copper		4.841.159.005.586
4.841.159.004.053	Zinc		4.841.159.004.312

**CJ 125**

**CJ 150**

<b>Pieces in box</b>		
	40	20
<b>Boxes on pallet</b>		
	88	88
<b>Box</b>		
	13.6	9.7
<b>Pallet</b>		
	1215	871

NOTE: The real Colors might be different from printed Colors on the leaflets. Please, see the samples before choosing the desired color.



EN 1462:2006

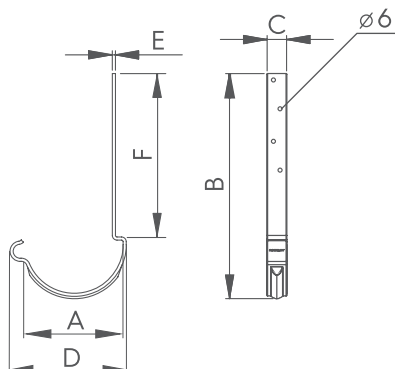

Element size (mm)

	125/87	150/100
<b>A</b>	125	150
<b>B</b>	350	375
<b>C</b>	25	30
<b>D</b>	150	177
<b>E</b>	4	4
<b>F</b>	270	270

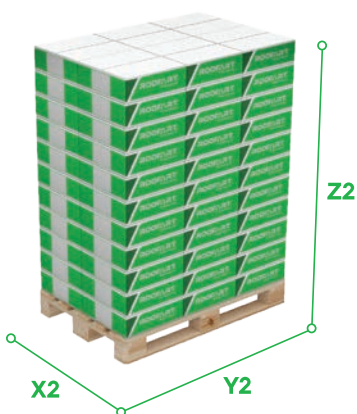
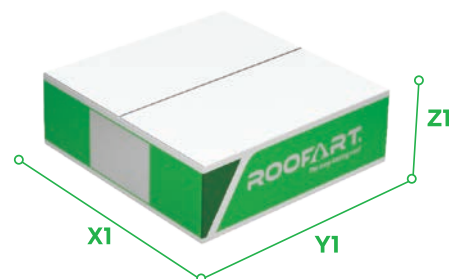

Pallet size (mm)

	125/87	150/100
<b>X2</b>	800	800
<b>Y2</b>	1200	1200
<b>Z2</b>	1635	1635

Box size (mm)

	125/87	150/100
<b>X1</b>	390	390
<b>Y1</b>	390	390
<b>Z1</b>	135	135

**CJL 125**

**CJL 150**

EAN-13 barcode	Colors	RAL	EAN-13 barcode
4.841.159.007.009	Wine red	3005	4.841.159.007.092
4.841.159.007.016	Oxide red	3009	4.841.159.007.108
4.841.159.007.023	Red	3011	4.841.159.007.115
4.841.159.010.504	Chrome green	6020	4.841.159.010.801
4.841.159.007.078	Iron grey	7011	4.841.159.007.160
4.841.159.017.183	Anthracite grey	7016	4.841.159.017.299
4.841.159.007.825	Copper brown	8004	4.841.159.008.112
4.841.159.007.030	Chocolate brown	8017	4.841.159.007.122
4.841.159.007.047	Grey brown	8019	4.841.159.007.139
4.841.159.007.054	Black	9005	4.841.159.007.146
4.841.159.007.061	Pure white	9010	4.841.159.007.153
4.841.159.017.596	Copper		4.841.159.017.602
4.841.159.007.085	Zinc		4.841.159.007.177

**CJL 125 CJL 150**

<b>Pieces in box</b>		
	30	20
<b>Boxes on pallet</b>		
	66	66
<b>Box</b>		
	13	12.1
<b>Pallet</b>		
	876	817

NOTE: The real Colors might be different from printed Colors on the leaflets. Please, see the samples before choosing the desired color.

EN 1462:2006

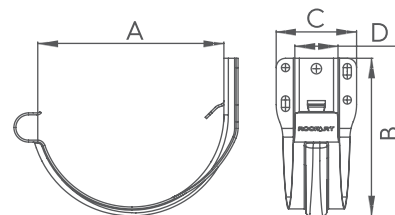

Element size (mm)

	125/87	150/100
<b>A</b>	125	150
<b>B</b>	110	137
<b>C</b>	54	57
<b>D</b>	25	25

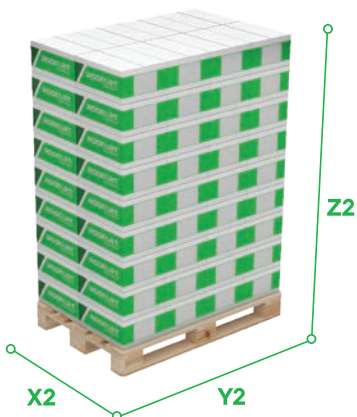

Pallet size (mm)

	125/87	150/100
<b>X2</b>	800	800
<b>Y2</b>	1200	1200
<b>Z2</b>	1580	1680

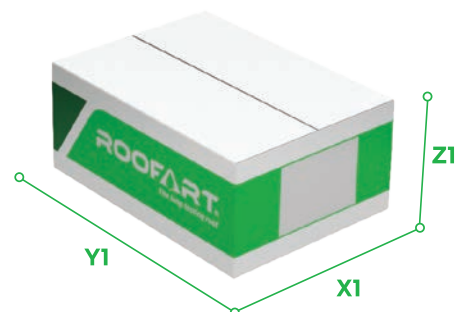













Box size (mm)





	125/87	150/100
<b>X1</b>	290	290
<b>Y1</b>	390	390
<b>Z1</b>	130	170

**CPU 125**

**CPU 150**

EAN-13 barcode	Colors	RAL	EAN-13 barcode
4.841.159.000.680	Wine red	 3005	4.841.159.001.984
4.841.159.000.420	Oxide red	 3009	4.841.159.001.724
4.841.159.000.161	Red	 3011	4.841.159.001.465
4.841.159.010.511	Chrome green	 6020	4.841.159.010.818
4.841.159.007.245	Iron grey	 7011	4.841.159.007.535
4.841.159.017.022	Anthracite grey	 7016	4.841.159.017.305
4.841.159.007.832	Copper brown	 8004	4.841.159.008.129
4.841.159.000.949	Chocolate brown	 8017	4.841.159.002.240
4.841.159.005.876	Grey brown	 8019	4.841.159.006.163
4.841.159.006.453	Black	 9005	4.841.159.006.743
4.841.159.001.205	Pure white	 9010	4.841.159.002.509
4.841.159.005.319	Copper		4.841.159.005.593
4.841.159.004.060	Zinc		4.841.159.004.329

**CPU 125 CPU 150**

<b>Pieces in box</b>		
	30	24
<b>Boxes on pallet</b>		
	88	72
<b>Box</b>		
	4.0	4.2
<b>Pallet</b>		
	372	322

NOTE: The real Colors might be different from printed Colors on the leaflets. Please, see the samples before choosing the desired color.

EN 1462:2006

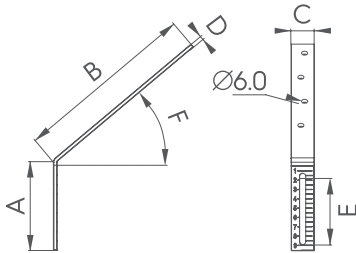

Element size (mm)

	125/87	150/100
<b>A</b>	95	95
<b>B</b>	190	190
<b>C</b>	25	25
<b>D</b>	4	4
<b>E</b>	70	70
<b>F</b>	40°	40°

Box size (mm)

	125/87	150/100
<b>X1</b>	200	200
<b>Y1</b>	300	300
<b>Z1</b>	110	110

Pallet size (mm)

	125/87	150/100
<b>X2</b>	800	800
<b>Y2</b>	1200	1200
<b>Z2</b>	590	590

PPC

	PPC	PPCR
<b>Pieces in box</b>	120	70
<b>Boxes on pallet</b>	64	64
<b>Box</b>	26	15.2
<b>Pallet</b>	1684	992

PPC

<b>EAN-13 barcode</b>	4.841.159.004.077
<b>Material</b>	Zinc coated steel

PPCR

<b>EAN-13 barcode</b>	4.841.159.014.946
<b>Material</b>	Zinc coated steel

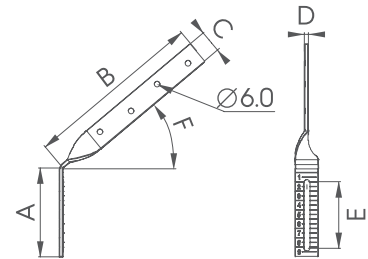
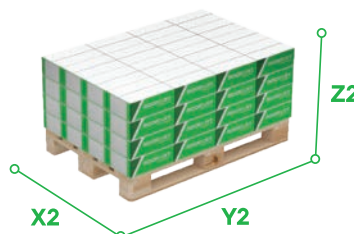
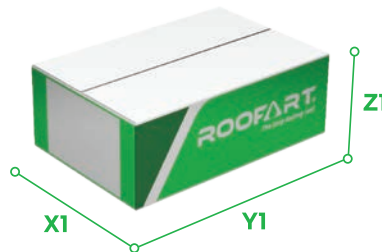

Element size (mm)

	125/87	150/100
<b>A</b>	95	95
<b>B</b>	190	190
<b>C</b>	25	25
<b>D</b>	4	4
<b>E</b>	70	70
<b>F</b>	40°	40°

Box size (mm)

	125/87	150/100
<b>X1</b>	200	200
<b>Y1</b>	300	300
<b>Z1</b>	110	110

Pallet size (mm)

	125/87	150/100
<b>X2</b>	800	800
<b>Y2</b>	1200	1200
<b>Z2</b>	590	590

# External 90° corner with brackets

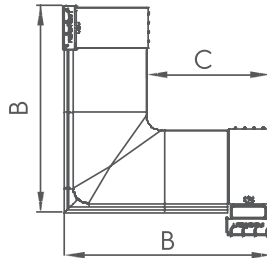

**Element size (mm)**

	125/87	150/100
<b>A</b>	125	150
<b>B</b>	337	350
<b>C</b>	195	180

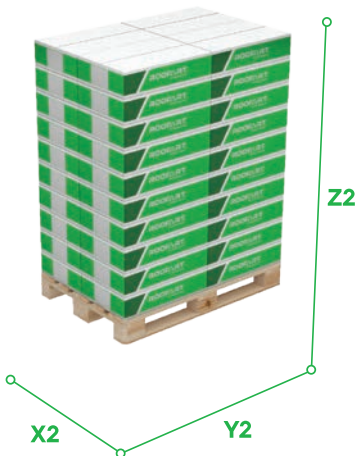

**Pallet size (mm)**

	125/87	150/100
<b>X2</b>	800	800
<b>Y2</b>	1200	1200
<b>Z2</b>	1850	1850

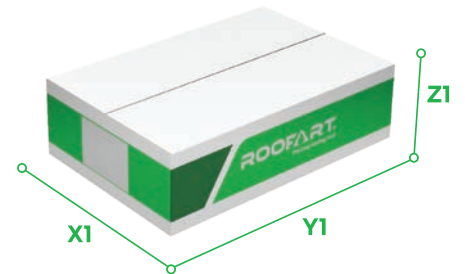

**Box size (mm)**

	125/87	150/100
<b>X1</b>	390	390
<b>Y1</b>	590	590
<b>Z1</b>	170	170

**KEB 125**

**KEB 150**

EAN-13 barcode	Colors	RAL	EAN-13 barcode
4.841.159.014.953	Wine red	3005	4.841.159.015.431
4.841.159.014.977	Oxide red	3009	4.841.159.015.455
4.841.159.014.991	Red	3011	4.841.159.015.479
4.841.159.015.011	Chrome green	6020	4.841.159.015.493
4.841.159.015.035	Iron grey	7011	4.841.159.015.516
4.841.159.017.039	Anthracite grey	7016	4.841.159.017.619
4.841.159.015.059	Copper brown	8004	4.841.159.015.530
4.841.159.015.073	Chocolate brown	8017	4.841.159.015.554
4.841.159.015.097	Grey brown	8019	4.841.159.015.578
4.841.159.015.110	Black	9005	4.841.159.015.592
4.841.159.015.134	Pure white	9010	4.841.159.015.615
4.841.159.015.172	Copper		4.841.159.015.653
4.841.159.015.158	Zinc		4.841.159.015.639

**KEB 125 KEB 150**

<b>Pieces in box</b>		
	8	6
<b>Boxes on pallet</b>		
	40	40
<b>Box</b>		
	6.2	6.2
<b>Pallet</b>		
	268	268

NOTE: The real Colors might be different from printed Colors on the leaflets. Please, see the samples before choosing the desired color.

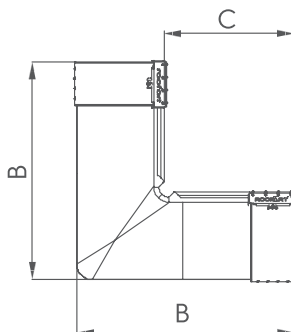
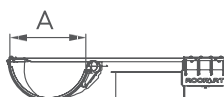

### Element size (mm)

	125/87	150/100
<b>A</b>	125	150
<b>B</b>	330	350
<b>C</b>	180	180

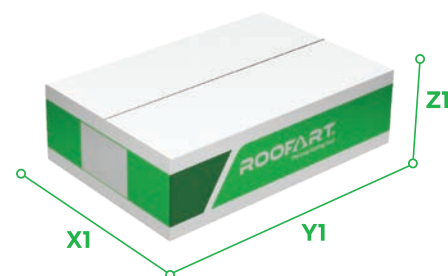

### Pallet size (mm)

	125/87	150/100
<b>X2</b>	800	800
<b>Y2</b>	1200	1200
<b>Z2</b>	1850	1850

### Box size (mm)

	125/87	150/100
<b>X1</b>	390	390
<b>Y1</b>	590	590
<b>Z1</b>	170	170

### KIB 125

### KIB 150

EAN-13 barcode	Colors	RAL	EAN-13 barcode
4.841.159.014.960	Wine red	3005	4.841.159.015.448
4.841.159.014.984	Oxide red	3009	4.841.159.015.462
4.841.159.015.004	Red	3011	4.841.159.015.486
4.841.159.015.028	Chrome green	6020	4.841.159.015.509
4.841.159.015.042	Iron grey	7011	4.841.159.015.523
4.841.159.017.053	Anthracite grey	7016	4.841.159.017.626
4.841.159.015.066	Copper brown	8004	4.841.159.015.547
4.841.159.015.080	Chocolate brown	8017	4.841.159.015.561
4.841.159.015.103	Grey brown	8019	4.841.159.015.585
4.841.159.015.127	Black	9005	4.841.159.015.608
4.841.159.015.141	Pure white	9010	4.841.159.015.622
4.841.159.015.189	Copper		4.841.159.015.660
4.841.159.015.165	Zinc		4.841.159.015.646

### KIB 125 KIB 150

	KIB 125	KIB 150
<b>Pieces in box</b>		
	8	6
<b>Boxes on pallet</b>		
	40	40
<b>Box</b>		
	6.0	6.0
<b>Pallet</b>		
	260	260

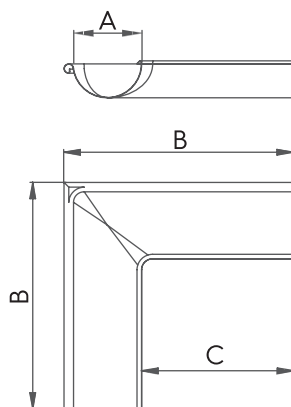

Element size (mm)		
	125/87	150/100
<b>A</b>	125	150
<b>B</b>	300	300
<b>C</b>	150	120

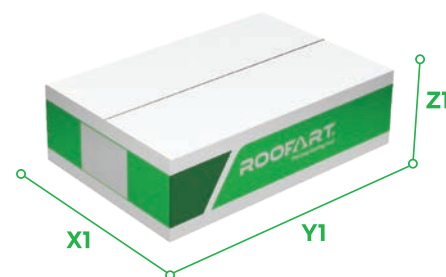

Pallet size (mm)		
	125/87	150/100
<b>X2</b>	800	800
<b>Y2</b>	1200	1200
<b>Z2</b>	1850	1850

Box size (mm)		
	125/87	150/100
<b>X1</b>	390	390
<b>Y1</b>	590	590
<b>Z1</b>	170	170

### KE 125

### KE 150

EAN-13 barcode	Colors	RAL	EAN-13 barcode
4.841.159.000.710	Wine red	3005	4.841.159.002.011
4.841.159.000.451	Oxide red	3009	4.841.159.001.755
4.841.159.000.192	Red	3011	4.841.159.001.496
4.841.159.010.559	Chrome green	6020	4.841.159.010.856
4.841.159.007.283	Iron grey	7011	4.841.159.007.573
4.841.159.017.527	Anthracite grey	7016	4.841.159.017.336
4.841.159.007.870	Copper brown	8004	4.841.159.008.167
4.841.159.000.970	Chocolate brown	8017	4.841.159.002.271
4.841.159.005.913	Grey brown	8019	4.841.159.006.200
4.841.159.006.491	Black	9005	4.841.159.006.781
4.841.159.001.236	Pure white	9010	4.841.159.002.530
4.841.159.005.357	Copper		4.841.159.005.630
4.841.159.004.107	Zinc		4.841.159.004.350

	KE 125	KE 150
<b>Pieces in box</b>		
	10	6
<b>Boxes on pallet</b>		
	40	40
<b>Box</b>		
	6.0	4.8
<b>Pallet</b>		
	260	212

Notă: Pot exista diferențe între culorile prezentate și cele reale. Pentru siguranță, verificați mostrele de tablă.

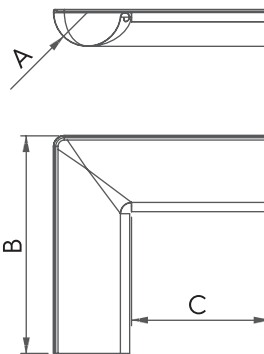

**Element size (mm)**

	125/87	150/100
<b>A</b>	125	150
<b>B</b>	300	300
<b>C</b>	150	120

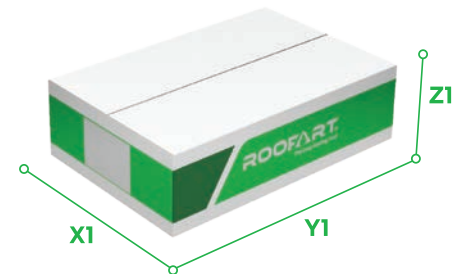

**Pallet size (mm)**













	125/87	150/100
<b>X2</b>	800	800
<b>Y2</b>	1200	1200
<b>Z2</b>	1850	1850

**Box size (mm)**





	125/87	150/100
<b>X1</b>	390	390
<b>Y1</b>	590	590
<b>Z1</b>	170	170

**KI 125**

**KI 150**

EAN-13 barcode	Colors	RAL	EAN-13 barcode
4.841.159.000.697	Wine red	 3005	4.841.159.001.991
4.841.159.000.437	Oxide red	 3009	4.841.159.001.731
4.841.159.000.178	Red	 3011	4.841.159.001.472
4.841.159.010.528	Chrome green	 6020	4.841.159.010.825
4.841.159.007.252	Iron grey	 7011	4.841.159.007.542
4.841.159.017.534	Anthracite grey	 7016	4.841.159.017.312
4.841.159.007.849	Copper brown	 8004	4.841.159.008.136
4.841.159.000.956	Chocolate brown	 8017	4.841.159.002.257
4.841.159.005.883	Grey brown	 8019	4.841.159.006.170
4.841.159.006.460	Black	 9005	4.841.159.006.750
4.841.159.001.212	Pure white	 9010	4.841.159.002.516
4.841.159.005.326	Copper		4.841.159.005.609
4.841.159.004.084	Zinc		4.841.159.004.336

**KI 125 KI 150**

<b>Pieces in box</b>		
	10	6
<b>Boxes on pallet</b>		
	40	40
<b>Box</b>		
 kg	6.0	4.8
<b>Pallet</b>		
 kg	260	210

NOTE: The real Colors might be different from printed Colors on the leaflets. Please, see the samples before choosing the desired color.

**PP  
180°**

# Straight overflow element 180°

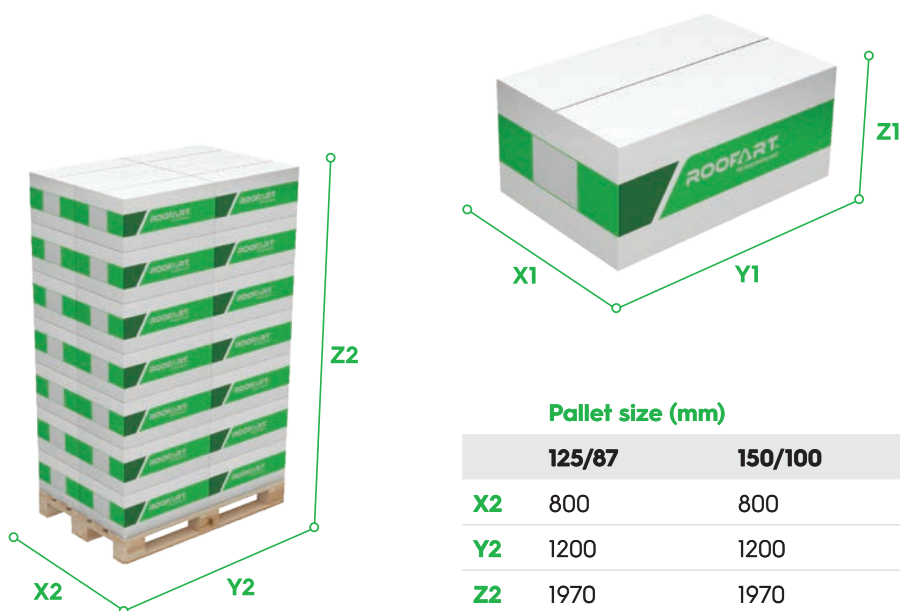
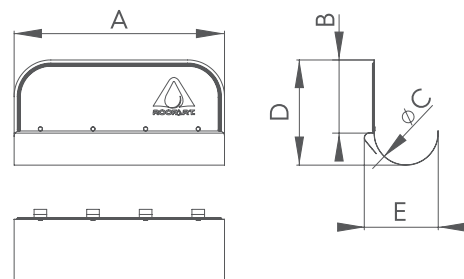

### Element size (mm)

	125/87	150/100
<b>A</b>	400	400
<b>B</b>	140	140
<b>C</b>	125	150
<b>D</b>	200	230
<b>E</b>	145	170

### Pallet size (mm)

	125/87	150/100
<b>X2</b>	800	800
<b>Y2</b>	1200	1200
<b>Z2</b>	1970	1970

### Box size (mm)

	125/87	150/100
<b>X1</b>	390	390
<b>Y1</b>	590	590
<b>Z1</b>	260	260

### PP 125/180°

### PP 150/180°

EAN-13 barcode	Colors	RAL	EAN-13 barcode
4.841.159.005.081	Wine red	3005	4.841.159.005.227
4.841.159.005.043	Oxide red	3009	4.841.159.005.180
4.841.159.005.074	Red	3011	4.841.159.005.210
4.841.159.010.733	Chrome green	6020	4.841.159.011.037
4.841.159.007.467	Iron grey	7011	4.841.159.007.757
4.841.159.017.220	Anthracite grey	7016	4.841.159.017.510
4.841.159.008.044	Copper brown	8004	4.841.159.008.334
4.841.159.005.050	Chocolate brown	8017	4.841.159.005.197
4.841.159.006.095	Grey brown	8019	4.841.159.006.385
4.841.159.006.675	Black	9005	4.841.159.006.965
4.841.159.005.067	Pure white	9010	4.841.159.005.203
4.841.159.005.104	Copper		4.841.159.005.241
4.841.159.005.098	Zinc		4.841.159.005.234

### PP 125 PP 150

	PP 125	PP 150
<b>Pieces in box</b>		
	10	10
<b>Boxes on pallet</b>		
	28	28
<b>Box</b>		
	6.8	8.0
<b>Pallet</b>		
	210	242

NOTE: The real Colors might be different from printed Colors on the leaflets. Please, see the samples before choosing the desired color.



**PP  
90°**

# Corner overflow element 90°

**ROOFART®**  
The long-lasting roof

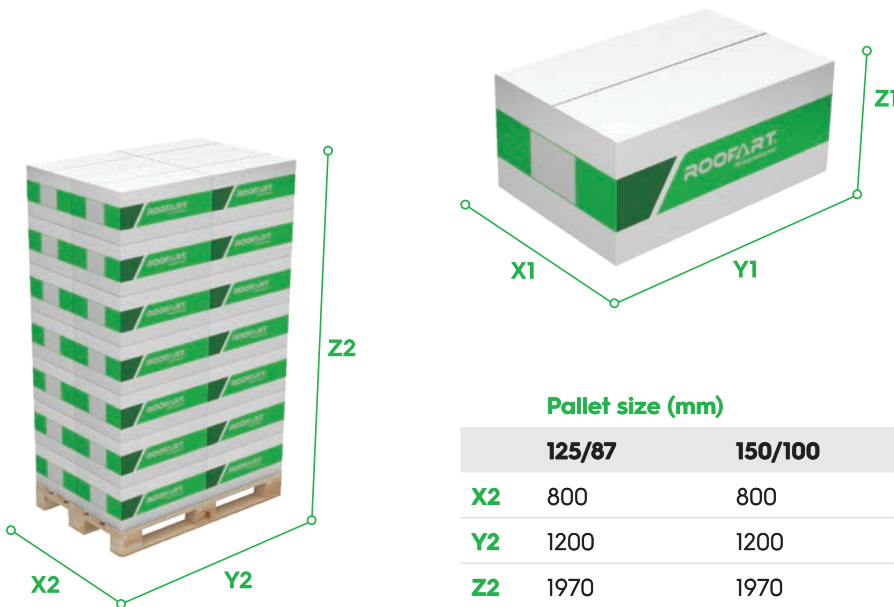
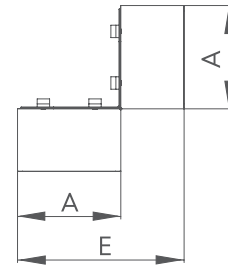
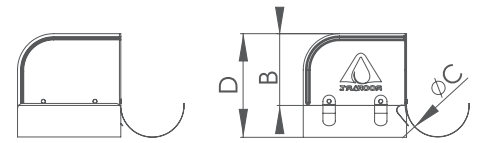

### Element size (mm)

	125/87	150/100
<b>A</b>	200	200
<b>B</b>	140	140
<b>C</b>	127	153
<b>D</b>	200	200
<b>E</b>	323	350

### Pallet size (mm)

	125/87	150/100
<b>X2</b>	800	800
<b>Y2</b>	1200	1200
<b>Z2</b>	1970	1970

### Box size (mm)

	125/87	150/100
<b>X1</b>	390	390
<b>Y1</b>	590	590
<b>Z1</b>	260	260

### PP 125/90°

### PP 150/90°

EAN-13 barcode	Colors	RAL	EAN-13 barcode
4.841.159.005.012	Wine red	3005	4.841.159.005.159
4.841.159.004.978	Oxide red	3009	4.841.159.005.111
4.841.159.005.005	Red	3011	4.841.159.005.142
4.841.159.010.726	Chrome green	6020	4.841.159.011.020
4.841.159.007.450	Iron grey	7011	4.841.159.007.740
4.841.159.017.213	Anthracite grey	7016	4.841.159.017.497
4.841.159.008.037	Copper brown	8004	4.841.159.008.327
4.841.159.004.985	Chocolate brown	8017	4.841.159.005.128
4.841.159.006.088	Grey brown	8019	4.841.159.006.378
4.841.159.006.668	Black	9005	4.841.159.006.958
4.841.159.004.992	Pure white	9010	4.841.159.005.135
4.841.159.005.036	Copper		4.841.159.005.173
4.841.159.005.029	Zinc		4.841.159.005.166

### PP 125 PP 150

	PP 125	PP 150
<b>Pieces in box</b>		
	6	6
<b>Boxes on pallet</b>		
	28	28
<b>Box</b>		
	4.5	5.1
<b>Pallet</b>		
	141	158

NOTE: The real Colors might be different from printed Colors on the leaflets. Please, see the samples before choosing the desired color.

# Rectangular hopper

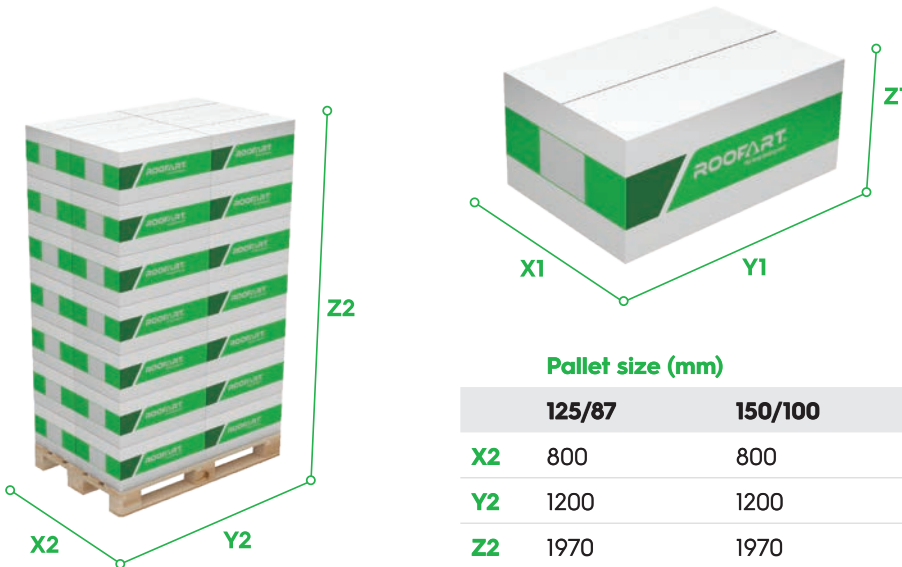
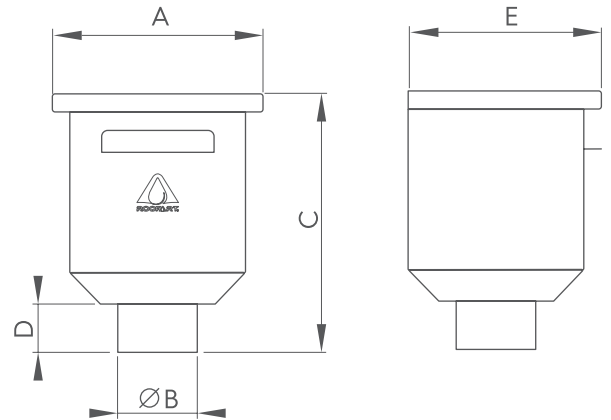

### Element size (mm)

	125/87	150/100
<b>A</b>	260	260
<b>B</b>	86	98
<b>C</b>	320	320
<b>D</b>	60	60
<b>E</b>	240	240

### Pallet size (mm)

	125/87	150/100
<b>X2</b>	800	800
<b>Y2</b>	1200	1200
<b>Z2</b>	1970	1970

### Box size (mm)

	125/87	150/100
<b>X1</b>	390	390
<b>Y1</b>	590	590
<b>Z1</b>	260	260

### PCD 87

### PCD 100

EAN-13 barcode	Colors	RAL	EAN-13 barcode
4.841.159.011.150	Wine red	3005	4.841.159.011.372
4.841.159.011.167	Oxide red	3009	4.841.159.011.389
4.841.159.011.174	Red	3011	4.841.159.011.396
4.841.159.011.242	Chrome green	6020	4.841.159.011.464
4.841.159.011.181	Iron grey	7011	4.841.159.011.402
4.841.159.017.176	Anthracite grey	7016	4.841.159.017.480
4.841.159.011.198	Copper brown	8004	4.841.159.011.419
4.841.159.011.204	Chocolate brown	8017	4.841.159.011.426
4.841.159.011.211	Grey brown	8019	4.841.159.011.433
4.841.159.011.228	Black	9005	4.841.159.011.440
4.841.159.011.235	Pure white	9010	4.841.159.011.457
4.841.159.015.295	Copper		4.841.159.015.301
4.841.159.011.259	Zinc		4.841.159.011.471

### PCD 87 PCD 100

	PCD 87	PCD 100
<b>Pieces in box</b>		
	2	2
<b>Boxes on pallet</b>		
	28	28
<b>Box</b>		
	3.7	3.7
<b>Pallet</b>		
	124	124

NOTE: The real Colors might be different from printed Colors on the leaflets. Please, see the samples before choosing the desired color.

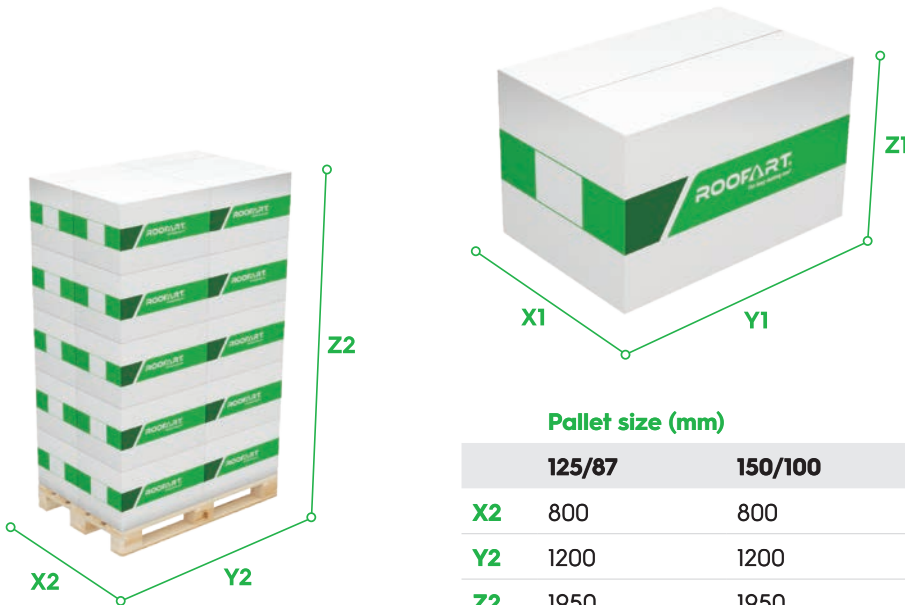
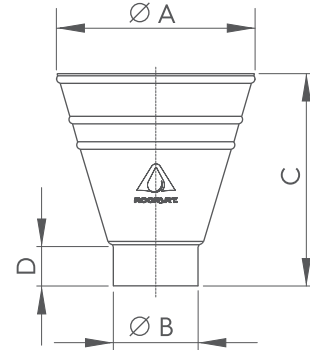

**Element size (mm)**

	125/87	150/100
<b>A</b>	200	250
<b>B</b>	86	98
<b>C</b>	200	250
<b>D</b>	40	40

**Pallet size (mm)**

	125/87	150/100
<b>X2</b>	800	800
<b>Y2</b>	1200	1200
<b>Z2</b>	1950	1950

**Box size (mm)**

	125/87	150/100
<b>X1</b>	390	390
<b>Y1</b>	590	590
<b>Z1</b>	360	360

**PC 87**

**PC 100**

EAN-13 barcode	Colors	RAL	EAN-13 barcode
4.841.159.000.864	Wine red	3005	4.841.159.002.165
4.841.159.000.604	Oxide red	3009	4.841.159.001.908
4.841.159.000.345	Red	3011	4.841.159.001.649
4.841.159.010.702	Chrome green	6020	4.841.159.011.006
4.841.159.007.436	Iron grey	7011	4.841.159.007.726
4.841.159.017.169	Anthracite grey	7016	4.841.159.017.473
4.841.159.008.013	Copper brown	8004	4.841.159.008.303
4.841.159.001.120	Chocolate brown	8017	4.841.159.002.424
4.841.159.006.064	Grey brown	8019	4.841.159.006.354
4.841.159.006.644	Black	9005	4.841.159.006.934
4.841.159.001.380	Pure white	9010	4.841.159.002.684
4.841.159.005.517	Copper		4.841.159.005.791
4.841.159.004.251	Zinc		4.841.159.004.503

**PC 87    PC 100**

<b>Pieces in box</b>		
	20	12
<b>Boxes on pallet</b>		
	20	20
<b>Box</b>		
	9.7	8.6
<b>Pallet</b>		
	214	192

NOTE: The real Colors might be different from printed Colors on the leaflets. Please, see the samples before choosing the desired color.

## Gutter outlet



Element size (mm)

	125/87	150/100
<b>A</b>	125	150
<b>B</b>	85	95
<b>C</b>	140	170
<b>D</b>	150	168
<b>E</b>	212	265
<b>F</b>	87	110
<b>G</b>	30	40

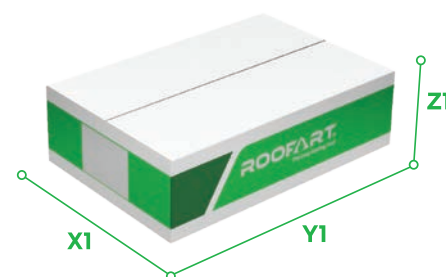
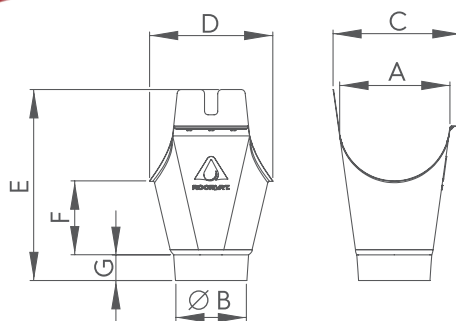

Pallet size (mm)

	125/87	150/100
<b>X2</b>	800	800
<b>Y2</b>	1200	1200
<b>Z2</b>	1550	1850

Box size (mm)

	125/87	150/100
<b>X1</b>	390	390
<b>Y1</b>	590	590
<b>Z1</b>	140	170

### RA 125

### RA 150

EAN-13 barcode	Colors	RAL	EAN-13 barcode
4.841.159.000.734	Wine red	3005	4.841.159.002.035
4.841.159.000.475	Oxide red	3009	4.841.159.001.779
4.841.159.000.215	Red	3011	4.841.159.001.519
4.841.159.010.580	Chrome green	6020	4.841.159.010.887
4.841.159.007.313	Iron grey	7011	4.841.159.007.603
4.841.159.017.077	Anthracite grey	7016	4.841.159.017.350
4.841.159.007.900	Copper brown	8004	4.841.159.008.198
4.841.159.000.994	Chocolate brown	8017	4.841.159.002.295
4.841.159.005.944	Grey brown	8019	4.841.159.006.231
4.841.159.006.521	Black	9005	4.841.159.006.811
4.841.159.001.250	Pure white	9010	4.841.159.002.554
4.841.159.005.388	Copper		4.841.159.005.661
4.841.159.004.121	Zinc		4.841.159.004.374

### RA 125 RA 150

	RA 125	RA 150
<b>Pieces in box</b>		
	24	24
<b>Boxes on pallet</b>		
	40	40
<b>Box</b>		
	7.0	9.1
<b>Pallet</b>		
	298	384

NOTE: The real Colors might be different from printed Colors on the leaflets. Please, see the samples before choosing the desired color.

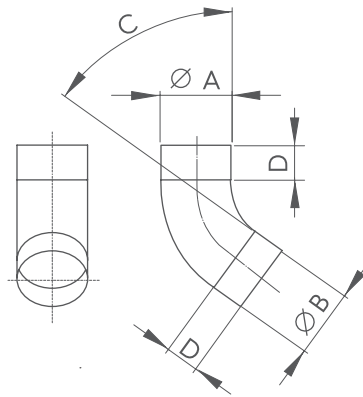

**Element size (mm)**

	125/87	150/100
<b>A</b>	87	100
<b>B</b>	86	98
<b>C</b>	60°	60°
<b>D</b>	50	50

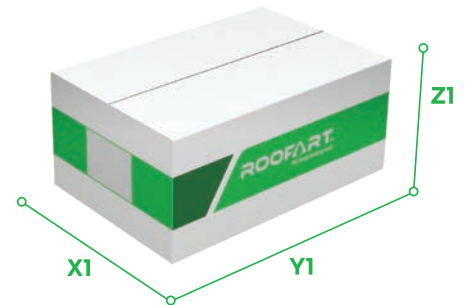

**Pallet size (mm)**

	125/87	150/100
<b>X2</b>	800	800
<b>Y2</b>	1200	1200
<b>Z2</b>	1970	1970

**Box size (mm)**

	125/87	150/100
<b>X1</b>	390	390
<b>Y1</b>	590	590
<b>Z1</b>	260	260

**CB 87**

**CB 100**

EAN-13 barcode	Colors	RAL	EAN-13 barcode
4.841.159.000.741	Wine red	3005	4.841.159.002.042
4.841.159.000.482	Oxide red	3009	4.841.159.001.786
4.841.159.000.222	Red	3011	4.841.159.001.526
4.841.159.010.597	Chrome green	6020	4.841.159.010.894
4.841.159.007.320	Iron grey	7011	4.841.159.007.610
4.841.159.017.084	Anthracite grey	7016	4.841.159.017.367
4.841.159.007.917	Copper brown	8004	4.841.159.008.204
4.841.159.001.007	Chocolate brown	8017	4.841.159.002.301
4.841.159.005.951	Grey brown	8019	4.841.159.006.248
4.841.159.006.538	Black	9005	4.841.159.006.828
4.841.159.001.267	Pure white	9010	4.841.159.002.561
4.841.159.005.395	Copper		4.841.159.005.678
4.841.159.004.138	Zinc		4.841.159.004.381

**CB 87    CB 100**

<b>Pieces in box</b> 	24	15
<b>Boxes on pallet</b> 	28	28
<b>Box</b> 	8.2	5.7
<b>Pallet</b> 	250	180

NOTE: The real Colors might be different from printed Colors on the leaflets. Please, see the samples before choosing the desired color.

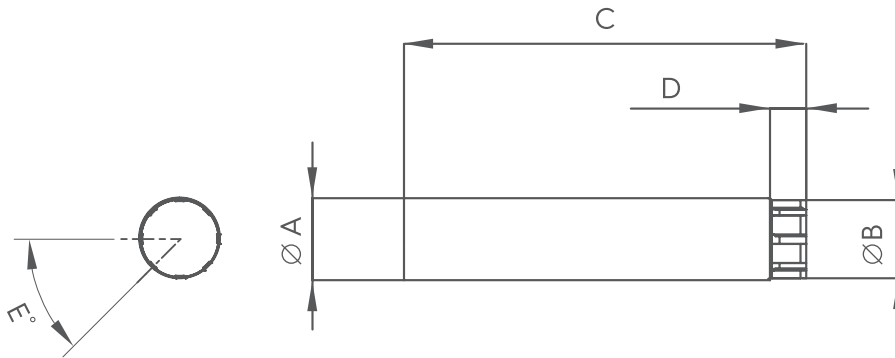
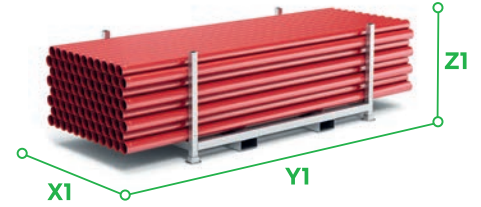

**Element size (mm)**

	125/87	150/100
<b>A</b>	87	100
<b>B</b>	86	98
<b>C</b>	3000	3000
<b>D</b>	50	50
<b>E</b>	45°	45°

**Pallet size (mm)**

	125/87	150/100
<b>X1</b>	1200	1200
<b>Y1</b>	3000	3000
<b>Z1</b>	810	810

**BU 87**

**BU 100**

EAN-13 barcode	Colors	RAL	EAN-13 barcode
4.841.159.000.796	Wine red	3005	4.841.159.002.097
4.841.159.000.536	Oxide red	3009	4.841.159.001.830
4.841.159.000.277	Red	3011	4.841.159.001.571
4.841.159.010.634	Chrome green	6020	4.841.159.010.931
4.841.159.007.368	Iron grey	7011	4.841.159.007.658
4.841.159.017.114	Anthracite grey	7016	4.841.159.017.398
4.841.159.007.955	Copper brown	8004	4.841.159.008.242
4.841.159.001.052	Chocolate brown	8017	4.841.159.002.356
4.841.159.005.999	Grey brown	8019	4.841.159.006.286
4.841.159.006.576	Black	9005	4.841.159.006.866
4.841.159.001.311	Pure white	9010	4.841.159.002.615
4.841.159.005.449	Copper		4.841.159.005.722
4.841.159.004.183	Zinc		4.841.159.004.435

**BU 87 BU 100**

<b>Pieces in pack</b>		
	2	2
<b>Packs on pallet</b>		
	36	30
<b>Pack</b>		
	7.9	8.8
<b>Pallet</b>		
	370	347

NOTE: The real Colors might be different from printed Colors on the leaflets. Please, see the samples before choosing the desired color.

EN 612:2006

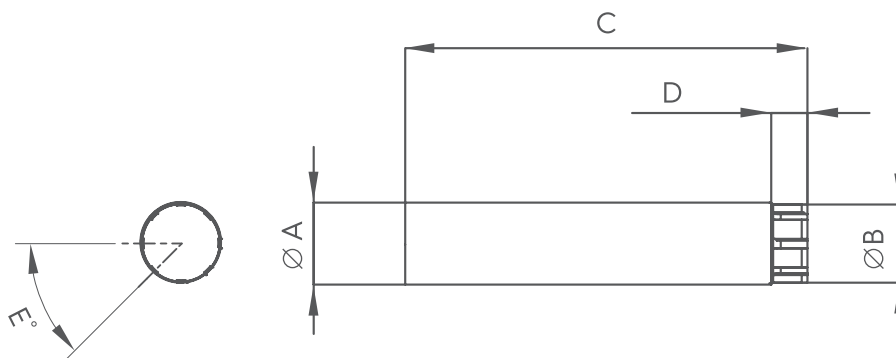
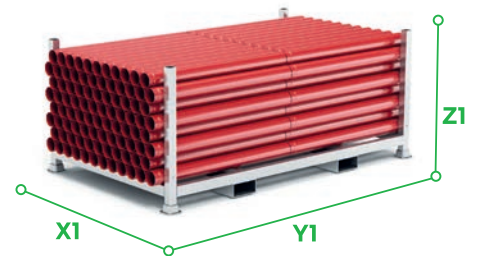

**Element size (mm)**

	125/87	150/100
<b>A</b>	87	100
<b>B</b>	86	98
<b>C</b>	1000	1000
<b>D</b>	50	50
<b>E</b>	45°	45°

**Pallet size (mm)**

	125/87	150/100
<b>X1</b>	1200	1200
<b>Y1</b>	2000	2000
<b>Z1</b>	810	810

**PB 87**

**PB 100**

EAN-13 barcode	Colors	RAL	EAN-13 barcode
4.841.159.000.765	Wine red	3005	4.841.159.002.066
4.841.159.000.505	Oxide red	3009	4.841.159.001.809
4.841.159.000.246	Red	3011	4.841.159.001.540
4.841.159.010.610	Chrome green	6020	4.841.159.010.917
4.841.159.007.344	Iron grey	7011	4.841.159.007.634
4.841.159.017.091	Anthracite grey	7016	4.841.159.017.374
4.841.159.007.931	Copper brown	8004	4.841.159.008.228
4.841.159.001.021	Chocolate brown	8017	4.841.159.002.325
4.841.159.005.975	Grey brown	8019	4.841.159.006.262
4.841.159.006.552	Black	9005	4.841.159.006.842
4.841.159.001.281	Pure white	9010	4.841.159.002.585
4.841.159.005.418	Copper		4.841.159.005.692
4.841.159.004.152	Zinc		4.841.159.004.404

**PB 87 PB 100**

<b>Pieces in pack</b>		
	2	2
<b>Packs on pallet</b>		
	72	60
<b>Pack</b>		
	2.6	2.9
<b>Pallet</b>		
	274	260

NOTE: The real Colors might be different from printed Colors on the leaflets. Please, see the samples before choosing the desired color.

# Downpipe holder



Element size (mm)

	125/87	150/100
<b>A</b>	87	100
<b>B</b>	125	150
<b>C</b>	80	80
<b>D</b>	90	90
<b>E</b>	30	30

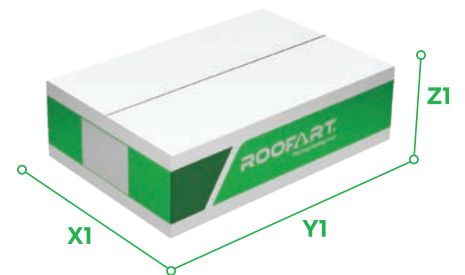
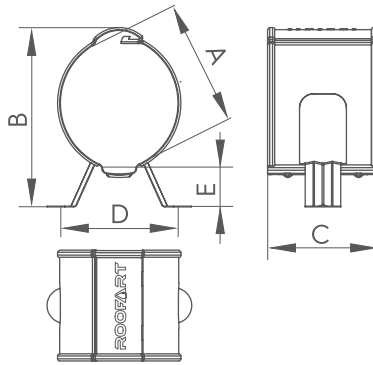

Pallet size (mm)

	125/87	150/100
<b>X2</b>	800	800
<b>Y2</b>	1200	1200
<b>Z2</b>	1850	1850

Box size (mm)

	125/87	150/100
<b>X1</b>	390	390
<b>Y1</b>	590	590
<b>Z1</b>	170	170

**BB 87**

**BB 100**

EAN-13 barcode	Colors	RAL	EAN-13 barcode
4.841.159.000.802	Wine red	3005	4.841.159.002.103
4.841.159.000.543	Oxide red	3009	4.841.159.001.847
4.841.159.000.284	Red	3011	4.841.159.001.588
4.841.159.010.658	Chrome green	6020	4.841.159.010.955
4.841.159.007.375	Iron grey	7011	4.841.159.007.665
4.841.159.017.121	Anthracite grey	7016	4.841.159.017.411
4.841.159.007.962	Copper brown	8004	4.841.159.008.259
4.841.159.001.069	Chocolate brown	8017	4.841.159.002.363
4.841.159.006.002	Grey brown	8019	4.841.159.006.293
4.841.159.006.583	Black	9005	4.841.159.006.873
4.841.159.001.328	Pure white	9010	4.841.159.002.622
4.841.159.005.456	Copper		4.841.159.005.739
4.841.159.004.190	Zinc		4.841.159.004.442

**BB 87 BB 100**

<b>Pieces in box</b>		
	44	40
<b>Boxes on pallet</b>		
	40	40
<b>Box</b>		
	6.0	6.2
<b>Pallet</b>		
	260	268

NOTE: The real Colors might be different from printed Colors on the leaflets. Please, see the samples before choosing the desired color.





**Element size (mm)**

	125/87	150/100
<b>A</b>	92	103
<b>B</b>	86	98
<b>C</b>	110	110
<b>D</b>	50	50

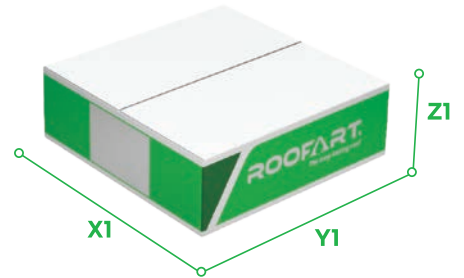
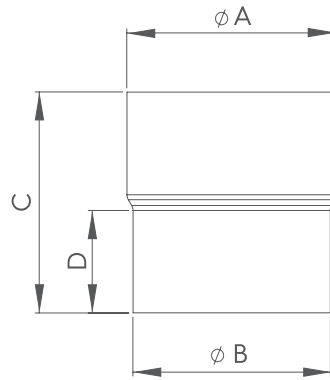

**Box size (mm)**

	125/87	150/100
<b>X1</b>	390	390
<b>Y1</b>	390	390
<b>Z1</b>	135	135

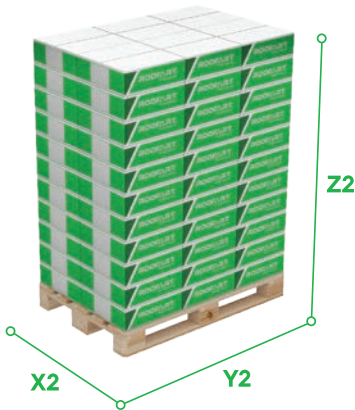

**Pallet size (mm)**

	125/87	150/100
<b>X2</b>	800	800
<b>Y2</b>	1200	1200
<b>Z2</b>	1635	1635

**MB 87**

**MB 100**

EAN-13 barcode	Colors	RAL	EAN-13 barcode
4.841.159.011.044	Wine red	3005	4.841.159.011.266
4.841.159.011.051	Oxide red	3009	4.841.159.011.273
4.841.159.011.068	Red	3011	4.841.159.011.280
4.841.159.011.136	Chrome green	6020	4.841.159.011.358
4.841.159.011.075	Iron grey	7011	4.841.159.011.297
4.841.159.017.206	Anthracite grey	7016	4.841.159.017.466
4.841.159.011.082	Copper brown	8004	4.841.159.011.303
4.841.159.011.099	Chocolate brown	8017	4.841.159.011.310
4.841.159.011.105	Grey brown	8019	4.841.159.011.327
4.841.159.011.112	Black	9005	4.841.159.011.334
4.841.159.011.129	Pure white	9010	4.841.159.011.341
4.841.159.015.424	Copper		4.841.159.015.417
4.841.159.011.143	Zinc		4.841.159.011.365

**MB 87 MB 100**

<b>Pieces in box</b>		
	17	14
<b>Boxes on pallet</b>		
	66	66
<b>Box</b>		
	2.6	2.4
<b>Pallet</b>		
	188	178

NOTE: The real Colors might be different from printed Colors on the leaflets. Please, see the samples before choosing the desired color.

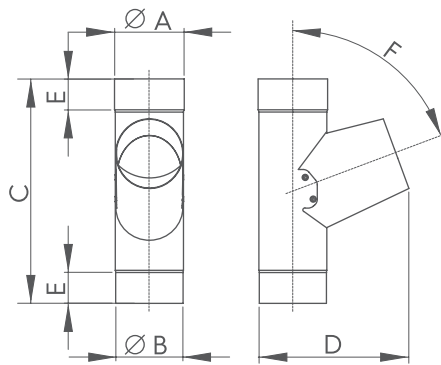

Element size (mm)

	125/87	150/100
<b>A</b>	89	100
<b>B</b>	86	98
<b>C</b>	290	310
<b>D</b>	180	190
<b>E</b>	40	40
<b>F</b>	60°	60°



Pallet size (mm)













	125/87	150/100
<b>X2</b>	800	800
<b>Y2</b>	1200	1200
<b>Z2</b>	1950	1950

Box size (mm)





	125/87	150/100
<b>X1</b>	390	390
<b>Y1</b>	590	590
<b>Z1</b>	360	360

### RB 87

### RB 100

EAN-13 barcode	Colors	RAL	EAN-13 barcode
4.841.159.000.826	Wine red	 3005	4.841.159.002.127
4.841.159.000.567	Oxide red	 3009	4.841.159.001.861
4.841.159.000.307	Red	 3011	4.841.159.001.601
4.841.159.010.665	Chrome green	 6020	4.841.159.010.962
4.841.159.007.399	Iron grey	 7011	4.841.159.007.689
4.841.159.017.138	Anthracite grey	 7016	4.841.159.017.428
4.841.159.007.979	Copper brown	 8004	4.841.159.008.266
4.841.159.001.083	Chocolate brown	 8017	4.841.159.002.387
4.841.159.006.026	Grey brown	 8019	4.841.159.006.316
4.841.159.006.606	Black	 9005	4.841.159.006.897
4.841.159.001.342	Pure white	 9010	4.841.159.002.646
4.841.159.005.470	Copper		4.841.159.005.753
4.841.159.004.213	Zinc		4.841.159.004.466

### RB 87 RB 100

<b>Pieces in box</b>		
	12	10
<b>Boxes on pallet</b>		
	20	20
<b>Box</b>		
	6.5	6.9
<b>Pallet</b>		
	150	158

NOTE: The real Colors might be different from printed Colors on the leaflets. Please, see the samples before choosing the desired color.

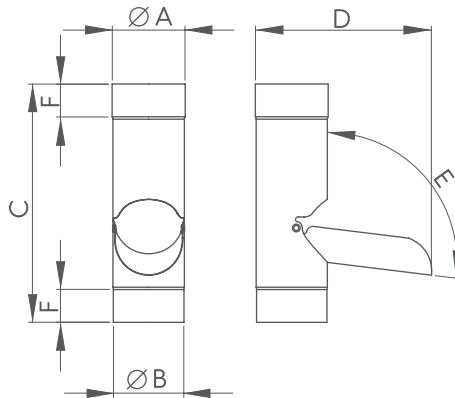

Element size (mm)

	125/87	150/100
<b>A</b>	89	100
<b>B</b>	86	98
<b>C</b>	290	350
<b>D</b>	200	230
<b>E</b>	105°	105°
<b>F</b>	40	40



Pallet size (mm)

	125/87	150/100
<b>X2</b>	800	800
<b>Y2</b>	1200	1200
<b>Z2</b>	1950	1950

Box size (mm)

	125/87	150/100
<b>X1</b>	390	390
<b>Y1</b>	590	590
<b>Z1</b>	360	360

**EC 87**

**EC 100**

EAN-13 barcode	Colors	RAL	EAN-13 barcode
4.841.159.000.857	Wine red	3005	4.841.159.002.158
4.841.159.000.598	Oxide red	3009	4.841.159.001.892
4.841.159.000.338	Red	3011	4.841.159.001.632
4.841.159.010.696	Chrome green	6020	4.841.159.010.993
4.841.159.007.429	Iron grey	7011	4.841.159.007.719
4.841.159.017.152	Anthracite grey	7016	4.841.159.017.442
4.841.159.008.006	Copper brown	8004	4.841.159.008.297
4.841.159.001.113	Chocolate brown	8017	4.841.159.002.417
4.841.159.006.057	Grey brown	8019	4.841.159.006.347
4.841.159.006.637	Black	9005	4.841.159.006.927
4.841.159.001.373	Pure white	9010	4.841.159.002.677
4.841.159.005.500	Copper		4.841.159.005.784
4.841.159.004.244	Zinc		4.841.159.004.497

**EC 87 EC 100**

	EC 87	EC 100
<b>Pieces in box</b> 	24	20
<b>Boxes on pallet</b> 	20	20
<b>Box</b> 	11.2	12.8
<b>Pallet</b> 	244	276

NOTE: The real Colors might be different from printed Colors on the leaflets. Please, see the samples before choosing the desired color.

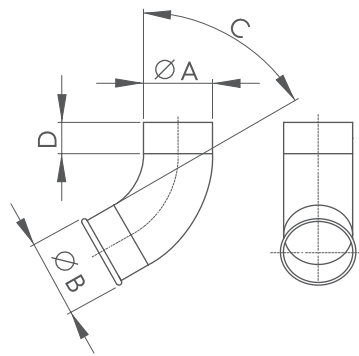

Element size (mm)

	125/87	150/100
<b>A</b>	87	100
<b>B</b>	90	103
<b>C</b>	60°	60°
<b>D</b>	50	50

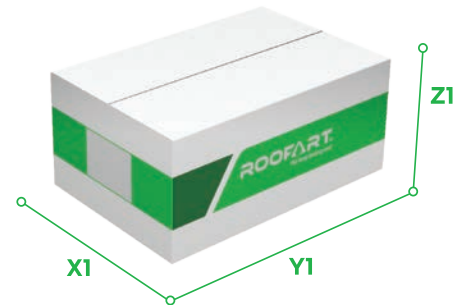

Pallet size (mm)

	125/87	150/100
<b>X2</b>	800	800
<b>Y2</b>	1200	1200
<b>Z2</b>	1970	1970

Box size (mm)

	125/87	150/100
<b>X1</b>	390	390
<b>Y1</b>	590	590
<b>Z1</b>	260	260

CE 87

CE 100

EAN-13 barcode	Colors	RAL	EAN-13 barcode
4.841.159.000.833	Wine red	3005	4.841.159.002.134
4.841.159.000.574	Oxide red	3009	4.841.159.001.878
4.841.159.000.314	Red	3011	4.841.159.001.618
4.841.159.010.672	Chrome green	6020	4.841.159.010.979
4.841.159.007.405	Iron grey	7011	4.841.159.007.696
4.841.159.017.145	Anthracite grey	7016	4.841.159.017.435
4.841.159.007.986	Copper brown	8004	4.841.159.008.273
4.841.159.001.090	Chocolate brown	8017	4.841.159.002.394
4.841.159.006.033	Grey brown	8019	4.841.159.006.323
4.841.159.006.613	Black	9005	4.841.159.006.903
4.841.159.001.359	Pure white	9010	4.841.159.002.653
4.841.159.005.487	Copper		4.841.159.005.760
4.841.159.004.220	Zinc		4.841.159.004.473

CE 87 CE 100

<b>Pieces in box</b>		
	24	15
<b>Boxes on pallet</b>		
	28	28
<b>Box</b>		
	8.2	5.7
<b>Pallet</b>		
	250	180

NOTE: The real Colors might be different from printed Colors on the leaflets. Please, see the samples before choosing the desired color.

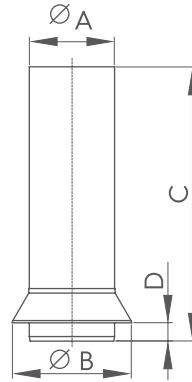

Element size (mm)

	125/87	150/100
<b>A</b>	90	104
<b>B</b>	130	145
<b>C</b>	300	310
<b>D</b>	20	20



Pallet size (mm)

	125/87	150/100
<b>X2</b>	800	800
<b>Y2</b>	1200	1200
<b>Z2</b>	1950	1950



Box size (mm)

	125/87	150/100
<b>X1</b>	390	390
<b>Y1</b>	590	590
<b>Z1</b>	360	360

**RC 87**

**RC 100**

EAN-13 barcode	Colors	RAL	EAN-13 barcode
4.841.159.000.871	Wine red	3005	4.841.159.002.172
4.841.159.000.611	Oxide red	3009	4.841.159.001.915
4.841.159.000.352	Red	3011	4.841.159.001.656
4.841.159.010.719	Chrome green	6020	4.841.159.011.013
4.841.159.007.443	Iron grey	7011	4.841.159.007.733
4.841.159.017.190	Anthracite grey	7016	4.841.159.017.459
4.841.159.008.020	Copper brown	8004	4.841.159.008.310
4.841.159.001.137	Chocolate brown	8017	4.841.159.002.431
4.841.159.006.071	Grey brown	8019	4.841.159.006.361
4.841.159.006.651	Black	9005	4.841.159.006.941
4.841.159.001.397	Pure white	9010	4.841.159.002.691
4.841.159.005.524	Copper		4.841.159.005.807
4.841.159.004.589	Zinc		4.841.159.004.510

**RC 87 RC 100**

<b>Pieces in box</b> 	15	12
<b>Boxes on pallet</b> 	20	20
<b>Box</b> 	8.0	7.2
<b>Pallet</b> 	178	162



NOTE: The real Colors might be different from printed Colors on the leaflets. Please, see the samples before choosing the desired color.

**DEP**

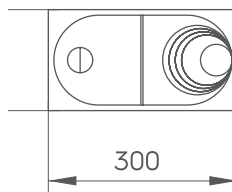
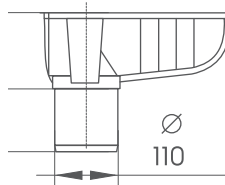
# Decanter

**DEP**

<b>EAN-13 barcode</b>	4.841.159.004.565
<b>Material</b>	PP

Colors		RAL
Chocolate brown		8017
Light grey		7035
Graphite grey		7024

**CEL**

# Elastic bend

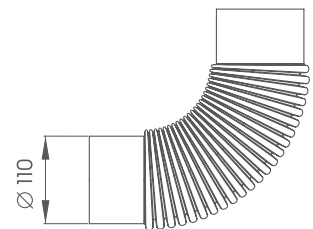
**CEL**

<b>EAN-13 barcode</b>	4.841.159.004.572
<b>Material</b>	PE

Colors		RAL
Jet black		9005

**EJ**

# Gutter joint element

EN 612:2006

**SJ**

# Gutter stabilizer

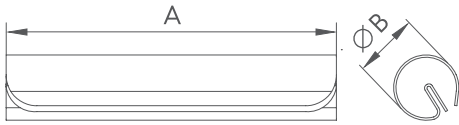
**Element size (mm)**

	125/87	150/100
<b>A</b>	140	140
<b>B</b>	16	18

**EJ**

<b>EAN-13 barcode</b>	<b>125</b>	4.841.159.006.989
	<b>150</b>	4.841.159.006.996
<b>Material</b>	Galvanized steel	

**Box size (mm)**

	125/87	150/100
<b>X1</b>	200	200
<b>Y1</b>	300	300
<b>Z1</b>	110	110

**Pallet size (mm)**

	125/87	150/100
<b>X2</b>	800	800
<b>Y2</b>	1200	1200
<b>Z2</b>	590	590

**EJ 125 EJ 150**

150	120	<b>Pieces in Box</b> 	80
64	64	<b>Boxes on pallet</b> 	64
5.0	4.4	<b>Box</b> 	3,8
322	302	<b>Pallet</b> 	263

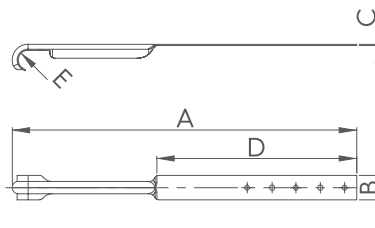
**Element size (mm)**

125/150	
<b>A</b>	283
<b>B</b>	20
<b>C</b>	1.0
<b>D</b>	164
<b>E</b>	R9

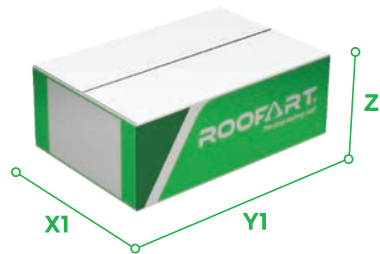
**SJ**

<b>EAN-13 barcode</b>	<b>RAL</b>
4.841.159.015.677	3005
4.841.159.015.684	3009
4.841.159.015.691	3011
4.841.159.015.707	6020
4.841.159.015.714	7011
4.841.159.017.633	7016
4.841.159.015.721	8004
4.841.159.015.738	8017
4.841.159.015.745	8019
4.841.159.015.752	9005
4.841.159.015.769	9010
4.841.159.015.783	Copper
4.841.159.015.776	Zinc

**Box size (mm)**

	125/87	150/100
<b>X1</b>	200	200
<b>Y1</b>	300	300
<b>Z1</b>	110	110

**Pallet size (mm)**

	125/87	150/100
<b>X2</b>	800	800
<b>Y2</b>	1200	1200
<b>Z2</b>	590	590

IM ROOFART SRL - Republic of Moldova  
799 Muncesti street, 2029 Chisinau

✉ info@roofart.md  
➔ www.roofart.md

SC ROOFART SRL - Romania  
111A Santionlunca, Covasna county 527137

☎ +40 372 900 222  
✉ contact@roofart.ro  
➔ www.roofart.ro

